

**Adjustments**

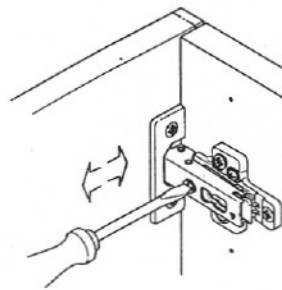

**Horizontal**  
by screw adjustment

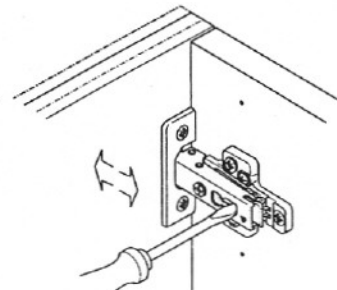

**In and out**  
by loosening the hinge-arm  
mounting screw

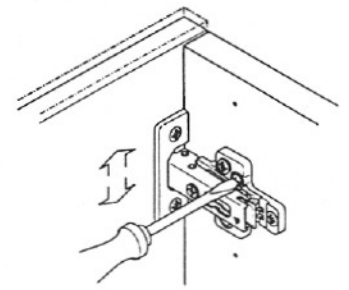

**Vertical**  
via slots in the mounting plate

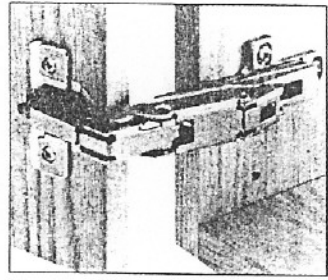

165 Degree Hinge

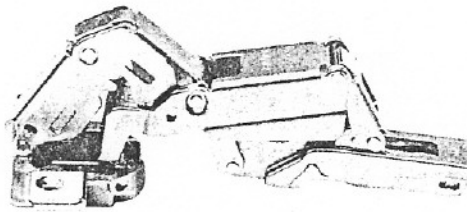

Your order may not need all of these items on this page

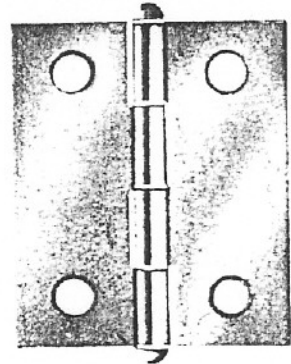

BUTT HINGE

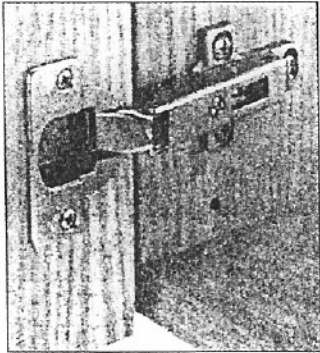

100 Degree Hinge

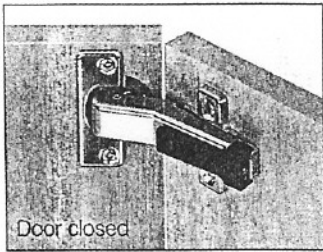
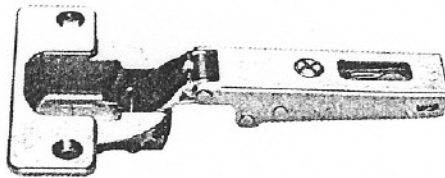

100 Degree Diagonal Hinge

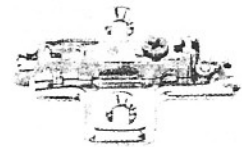
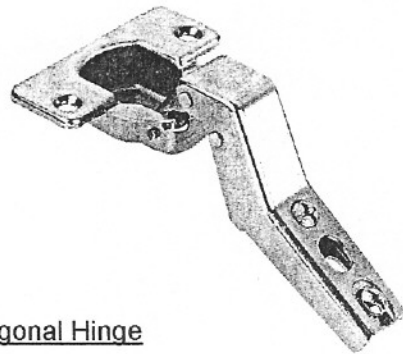

0mm HINGE PLATE

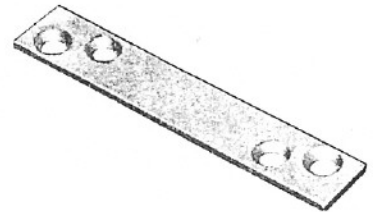

MENDING PLATE

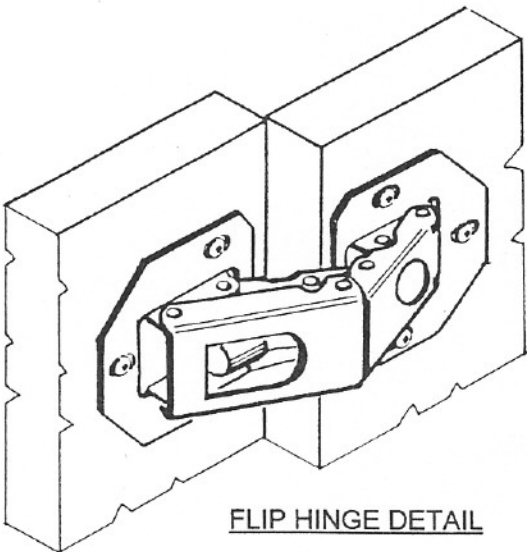

FLIP HINGE DETAIL

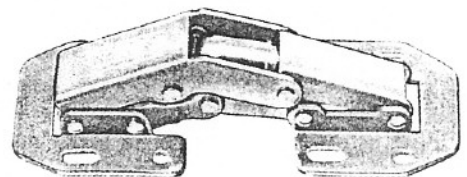

FLIP HINGE

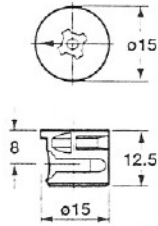

**CAM**

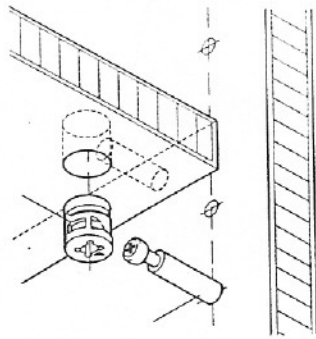

**PIN & CAM DETAIL**

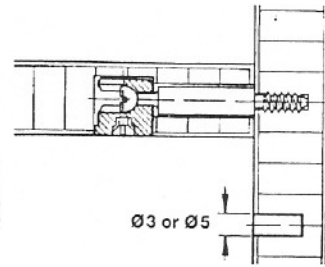

**PIN & CAM DETAIL**

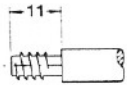
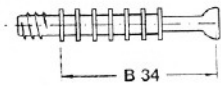
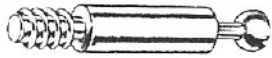

**PIN**

Bracket 1/2 x 1 3/4 x 1 3/4"  
16 gauge

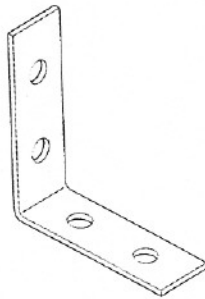

**"L"**

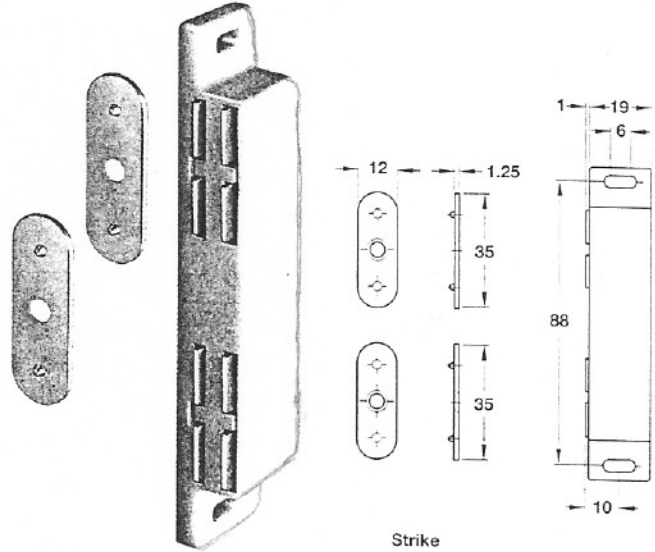

Strike

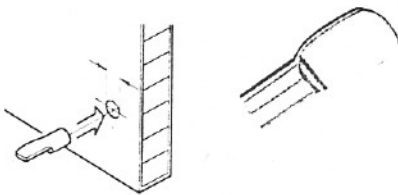

**SHELF PIN**

**DBL MAGNET**

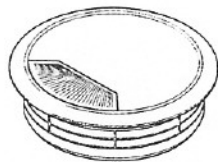
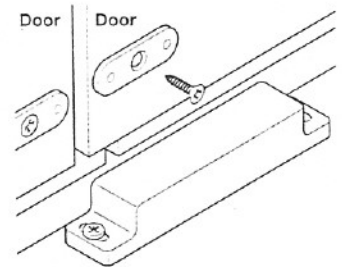

**GROMMET**

Your order may not need all of these items on this page

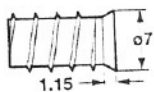

**EURO**



**SCREW SIZES**

- #6 (5/8)                      #10 (1 1/4)
- #6 (1 1/4)
- #6 (1 5/8)
- #6 (2)
- #6 (2 1/2)

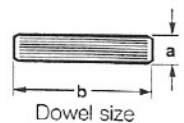
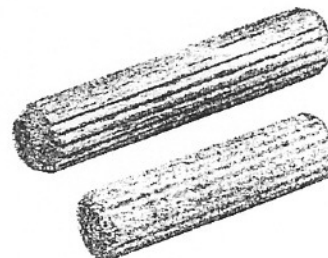

Dowel size

**DOWEL**